



The choice to make when superior quality and service count.

2655 Airport Rd. • Santa Teresa • NM • 88008 • Ph 505.589.2130 • Fx 505.589.2608

MODEL MMP-3PS

Pipe Roller Supports for Non-Insulated Roof Decks and all Existing Roofs

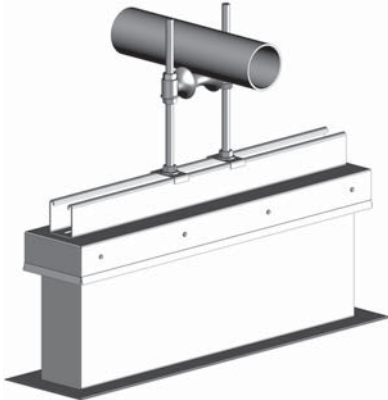

SUBMITTAL

Project: _____

Contractor: _____

Architect: _____

Engineer: _____

Date: _____

Submitted by: _____

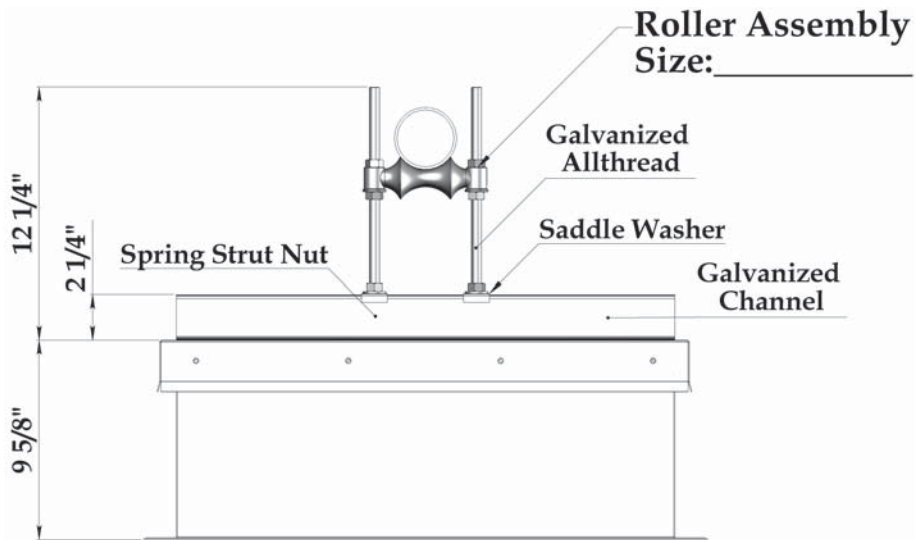

FINISHED DIMENSIONS

Support Dimensions

Roller Dimensions

QTY	L	H	S

QTY	Roller Chair Size	RL

Job Description